

# Windseal

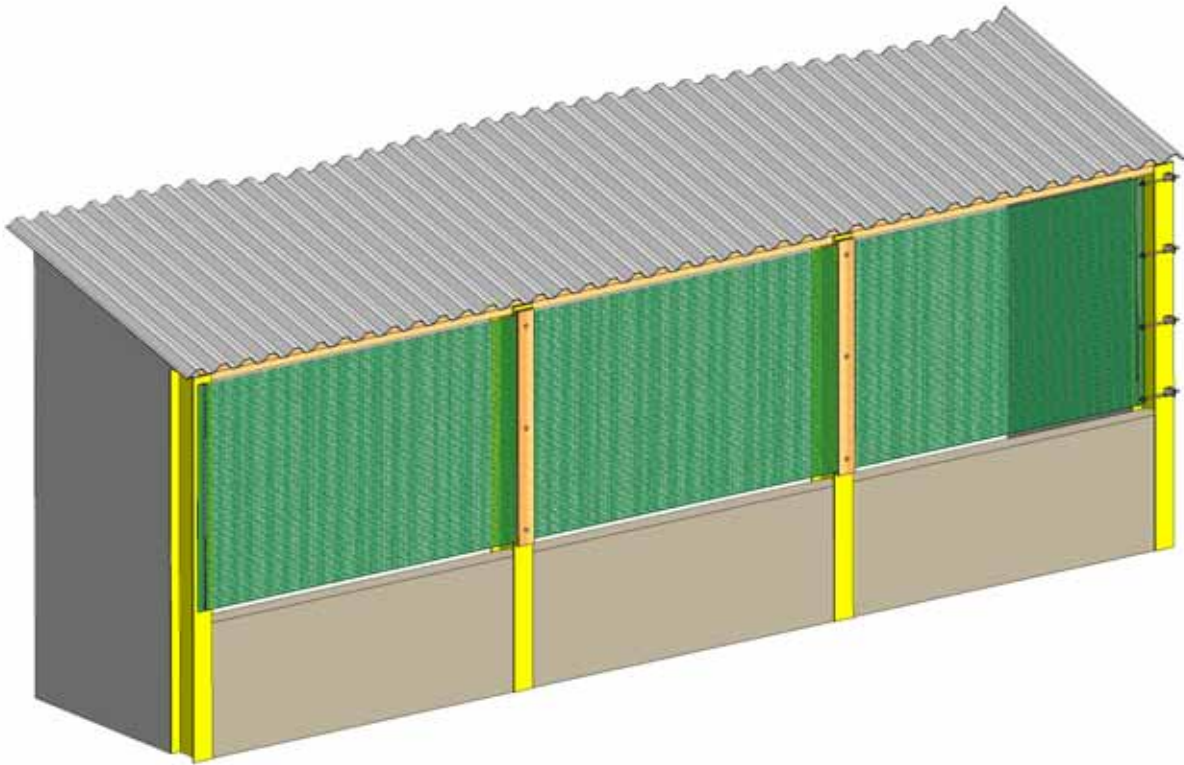

Installation Instructions

ENG

Instructions d'installation

FR

Montageanleitung

DE







Montageaanwijzingen

NL

Installationsinstruktioner





DK

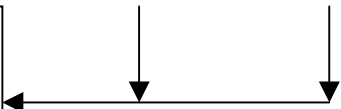

| Windseal Kit Contents • Le Kit Windseal Contient • Het Windseal Pakket Bevat • Windsealsystem Beinhaltet |   |   |   |   |   |                        |   |
|--|---|---|---|---|---|------------------------|---|
|  | a   | b   | c   |   | d <sub>1</sub>  |                        |   |
| Depth  | Sets of profiles (Female)   | Sets of profiles (Male)   | Angle brackets  | M8x20 sets/washers/nuts   | M12 nuts  | M12x300 threaded bar   | M12x50 square washer  |
| Largeur  | Nombre de profils (Femelles)  | Nombre de profils (Mâles)   | Nombre d'équerres   | M8x20 boulons/écrous/rondelles  | M12 boulons   | M12x300 tiges filetées | M12x50 rondelles carrées  |
| Diepte   | Set profillen (Vrouwlijk)   | Set profilen (Mannelijk)  | Rechthoekige haken  | M8x20 bout/ ring/en moer  | M12 moeren  | M12x300 draadeinden    | M12x50 vierkante plaatjes   |
| Maße   | Profilteile (weiblich)  | Profilteile (männlich)  | Rechtwinkligen  | M8x20 Schrauben/Muttern/Unterlegscheiben  | M12 Muttern   | M12x300 Gewindestangen | M12x50 viereckige unterlegscheiben  |
|  |  |  |  |  |  |                        |  |
| 50cm   | 2   | 2   | 2   | 2   | 6   | 2                      | 2   |
| 75cm   | 2   | 2   | 3   | 3   | 9   | 3                      | 3   |
| 100cm  | 2   | 2   | 3   | 3   | 9   | 3                      | 3   |
| 150cm  | 2   | 3   | 4   | 4   | 12  | 4                      | 4   |
| 200cm  | 2   | 4   | 5   | 5   | 15  | 5                      | 5   |
| 300cm  | 2   | 6   | 7   | 7   | 21  | 7                      | 7   |

Can be replaced by optional ratchet tensioning kit  
 Ces pieces peuvent être remplacées par les pieces en option (cliquets tendeurs etc)  
 Extra aan te vagen spannerset (in plaats van draadeind met vierkante plaatjes)  
 Möglich zur ersetzen durch spanner und spannung set



| Optional ratchet tensioning kit • Kit de tension avec cliquet tendeur • En option spanner und spannung set auch zu bekommen mit • (Optie) extra spannerset |   |   |   |   |
|--|---|---|---|---|
| d <sub>2</sub>   |   |   |   |   |
| Depth  | M12 Eyebolts  | 125cm x 25mm Webbing  | Hook and ratchets   | Mini rave hooks   |
| Largeur  | Boulons à rondelles M12   | Sangles 125cm x 25mm  | Cliquets tendeurs 800kg   | Crochets  |
| Diepte   | Aantal oogbouten  | Aantal bouden   | Aantal spanners   | Aantal haben  |
| Maße   | Anzahl der ringschrauben  | Aazahl der Gurtbänder   | Anzahl der ratschen   | Anzhal der haken  |
|  |  |  |  |  |
| 50cm   | 2   | 2   | 2   | 2   |
| 75cm   | 3   | 3   | 3   | 3   |
| 100cm  | 3   | 3   | 3   | 3   |
| 150cm  | 4   | 4   | 4   | 4   |
| 200cm  | 5   | 5   | 5   | 5   |
| 300cm  | 7   | 7   | 7   | 7   |

Does not contain • Ne contient pas • Bevat niet • Nicht zum Inhalt gehörend

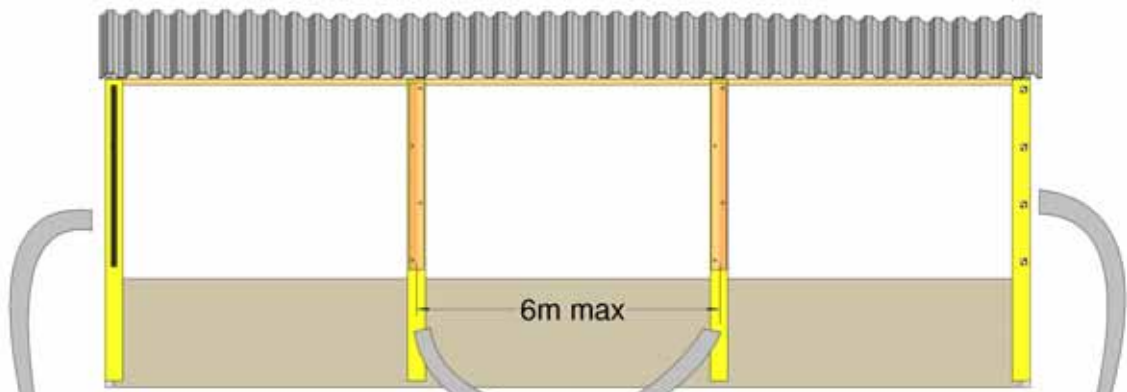
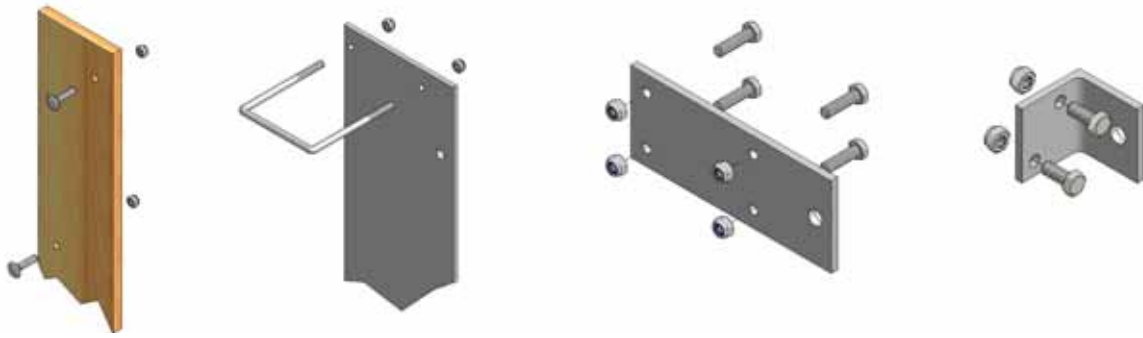

Not Supplied • Ne contient pas • niet meegeleverd • Nicht Bestandteil der Lieferung

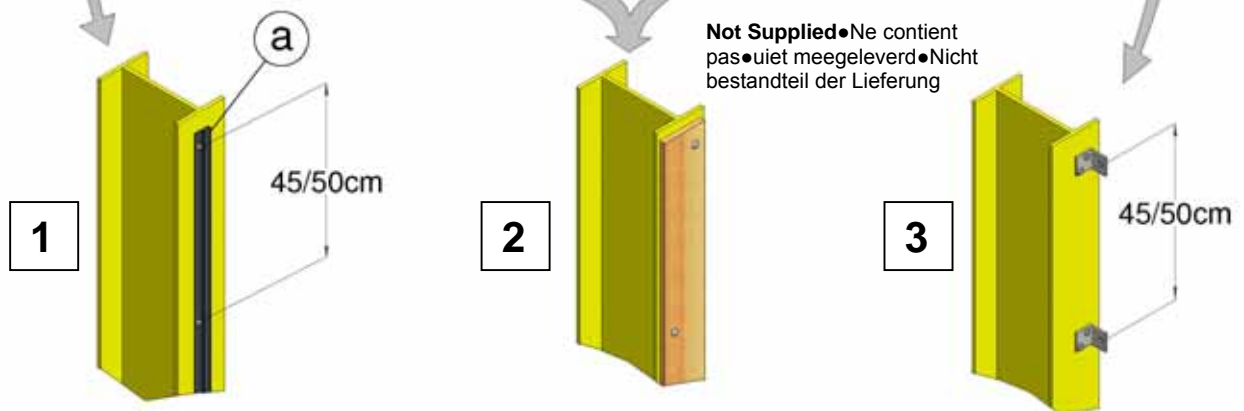

**1** Fixing variations • Variante de fixation • Bevestigingsvarianties • Befestigungsalternative

**3** Fixing variations • Variante de fixation • Bevestigingsvarianties • Befestigungsalternative

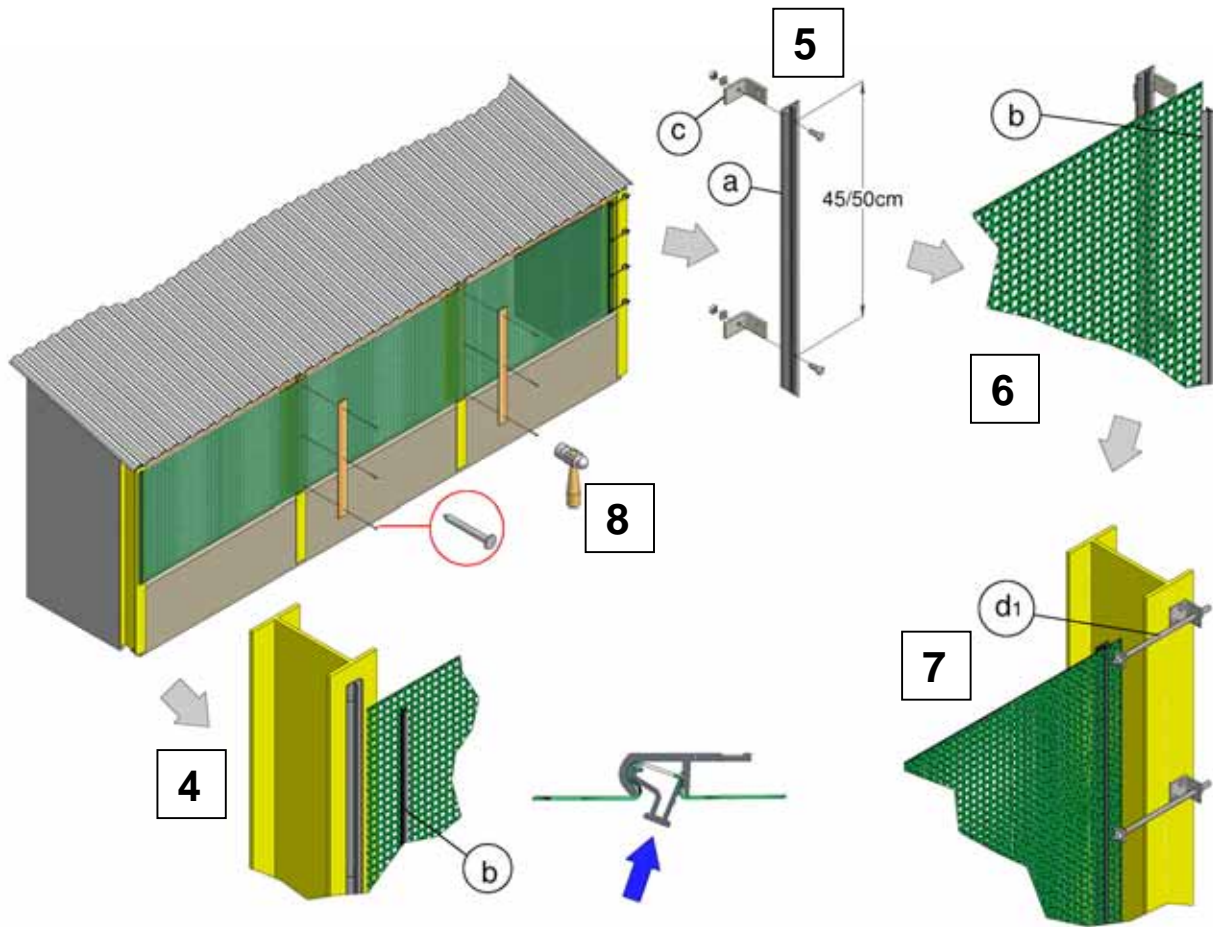

**Optional ratchet tensioning kit** • Kit de tension avec cliquet tendeur • En option spanner und spannung set auch zu bekommen mit • (Optie) extra spanner set

