

VentLogic® AD10

ENG



Installation and Operating Instructions



Description of Control Box

1.1 Introduction

The aim of these operating instructions is to allow the operator to use the controller in a meaningful and safe manner. Always observe the safety information provided in Section 3 to rule out the possibility of hazards occurring. Section 4 contains a description of how the controller operates. Section 5 details how the controller is to be installed and set up.

ENG

Throughout this instruction manual particular aspects of the installation and operation of the controller have been highlighted. Please refer to the following symbols to show how key instructions are categorized.



CAUTION: Potentially hazardous situation: must be avoided otherwise injuries may result.



ATTENTION: Observe the given instructions otherwise the product or adjacent items may be damaged

NOTE: Helpful comments and information to assist in installation or use of your product

NOTE: Before starting the installation you must fully read these instructions (including the separate electrical details) to completely understand the procedure.

Keep the instructions supplied for reference purposes.

NOTE: Colour versions of the installation instructions can be downloaded from our website:

www.galebreaker.com

1.2 Intended Use

- The AD10 controller is designed to operate a Galebreaker auto-locking door in conjunction with the Galebreaker bottom tube position sensing system.
- After the switch is activated, it is able to control the door in a safe and controlled manner with the operator in attendance unless a safety edge device is installed in which case the door can be operated without the operator in attendance.
- The controller incorporates a radio receiver option to allow the door to be operated from a remote position when combined with a safety edge device.

ENG

1.3 Technical Data

Unit Name:	AD10
Casing:	IP 44 plastic casing
Connection Voltage:	230 Volt AC / 50Hz
Secondary Supply Fuse:	T6.3AH 250V
Operating Temp:	-20 to +40°C

2 General Information

2.1 Copyright

The copyright for these operating instructions belongs to:

**Galebreaker Agri Ltd., Galebreaker House,
New Mills Industrial Estate, Ledbury. HR8 2SS**

These operating instructions must not be reproduced, divulged, used for the purpose of unauthorised competition or disseminated to third parties in part or in whole. Infringements to the above will result in claims for damages.

Subject to alterations in design.



ATTENTION: These operating instructions only apply to the control box in question and are not intended for the complete system.

2.2 Design Principle for This Equipment

- The controller is only intended for the tasks detailed in Section 1.2. Unless agreed by contract, any other form of use or a more extensive form of use is considered to be contrary to the intended use. The manufacturer is not responsible for any resulting damage. The user/company bears all associated risks.
- Observing the procedures provided in these operating instructions for assembly, operation and maintenance also forms part of the compliance with the intended use.

ENG

2.3 Directions for Use

- The manufacturer reserves the right to modify the design and technical data in the interests of further development.
- Claims cannot therefore be derived from details, illustrations or drawings and descriptions.
- Before starting installation, familiarise yourself with the actions required for assembly, settings, operation and maintenance.
- The recognised specialist rules of safety and specialised work, must be observed in addition to these operating instructions and relevant accident prevention rulings applicable in the country of use.
- The control box may represent hazards if they are used incorrectly by untrained staff or are not used for their intended purpose.

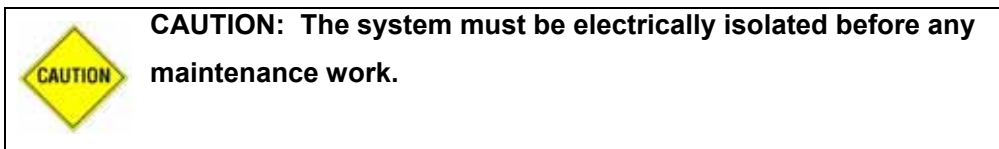

2.4 Transport and Storage

- The controller is suitably packaged ex-factory for the agreed form of transport.
- Only transport the control unit in its original packaging.
- Avoid impact and collisions.
- Note whether the packaging or control unit is damaged.
- Store the control unit in its original packaging in a dry place with protection from the weather.
- Avoid extremes of temperature.

3 Safety Measures

3.1 Electrical / Electronic Equipment



CAUTION: Work on electrical components / assemblies may only be undertaken by an electrician or competent person in accordance with technical electrical rulings. The contractor or operator must also ensure that the electrical systems and operating equipment are operated and maintained in accordance with technical electrical rulings.

ENG



CAUTION: Care must be undertaken when working on live parts. Components under the lower cover have limited protection. You may come into direct contact with dangerous voltages.

- Whilst the controller is in normal use all covers must be secured in place.
- Fuses may only be replaced; they must not be repaired or bridged.
- Only use the fuses specified in Section 1.3.
- De-energised statuses must be monitored using a two-pin monitoring device.
- Electrically isolate the controller before removing any covers.



CAUTION: Any defects established on electrical systems/ assemblies/operating equipment must be rectified immediately. If the unit represents an acute hazard in its current condition, the unit/system must not be operated in this defective condition.

3.2 Accessories, Spare Parts



CAUTION: Only use parts and additional equipment that have been approved and/or recommended by Galebreaker Agri Ltd. A judgement cannot be made as to whether external products or other modifications not approved or recommended by Galebreaker Agri Ltd result in a safety risk when used in conjunction with the Controller.

ENG

3.3 Address of Manufacturer

If you have any questions about how to use our products or if you are planning special applications, please contact:

Galebreaker Agri Ltd., Galebreaker House
New Mills Industrial Estate, Ledbury
Herefordshire. HR8 2SS
United Kingdom
Tel: +44 (0) 1531 637900
Fax: +44 (0) 1531 637901

4 Installation

Internal Installation only

Remove lower lid to expose lower fixing points.

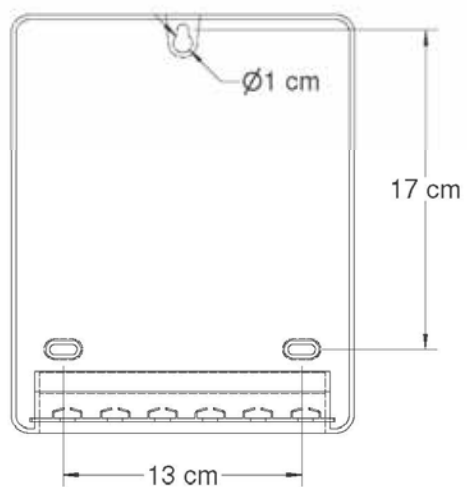
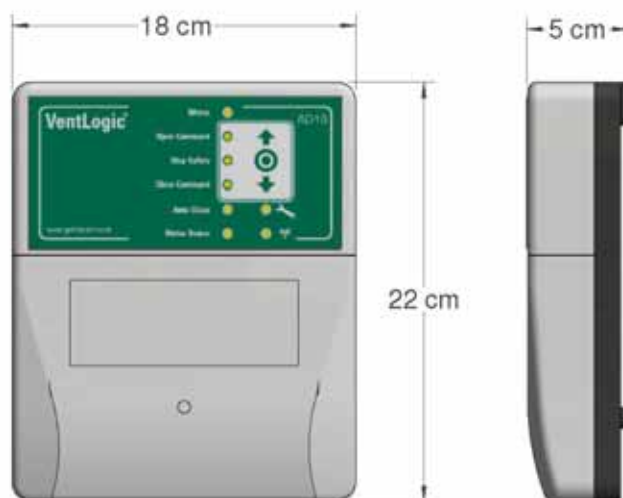

ENG

5 Operation

5.1 Overview

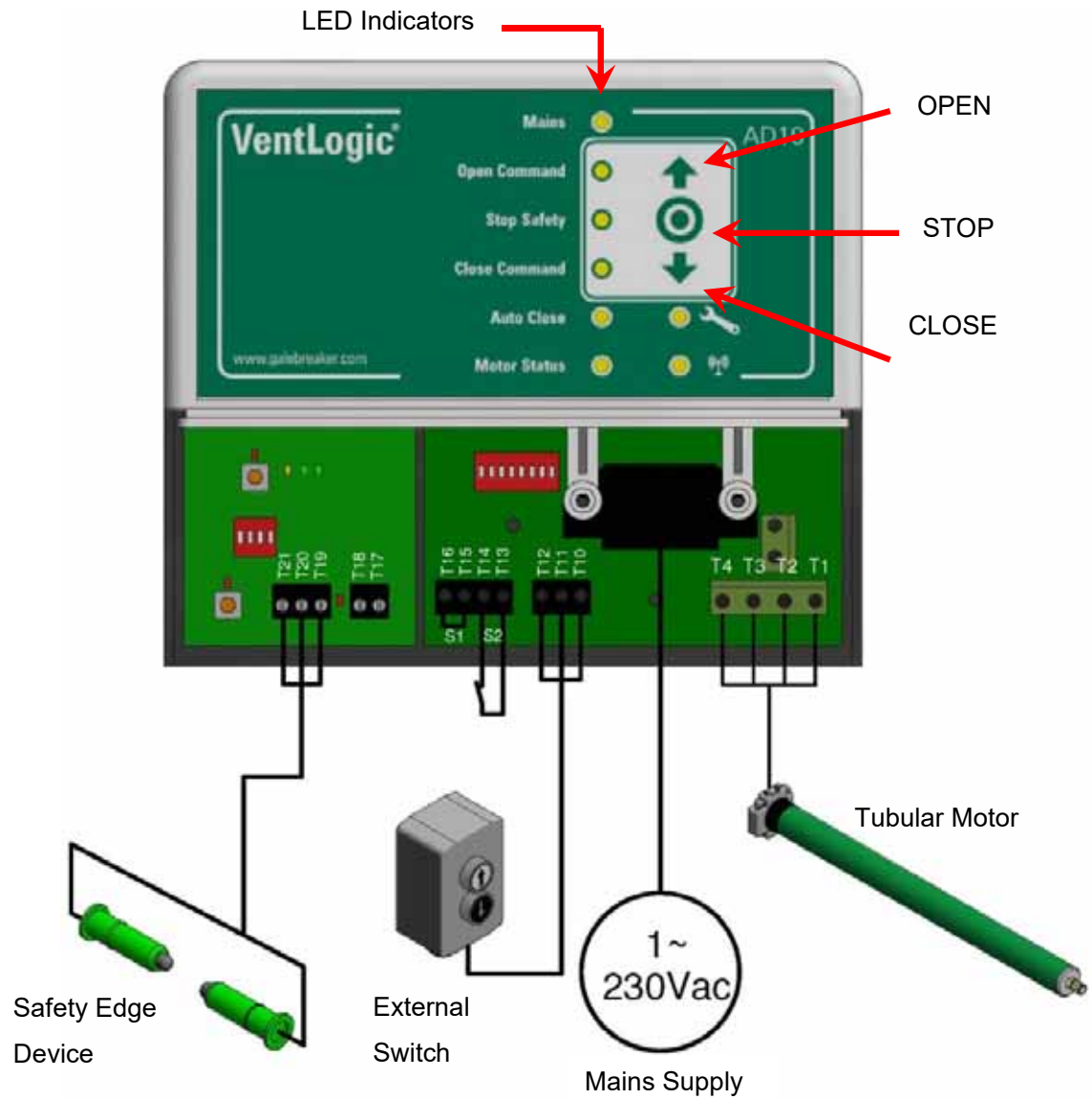

5.2 Electrical Installation

ENG

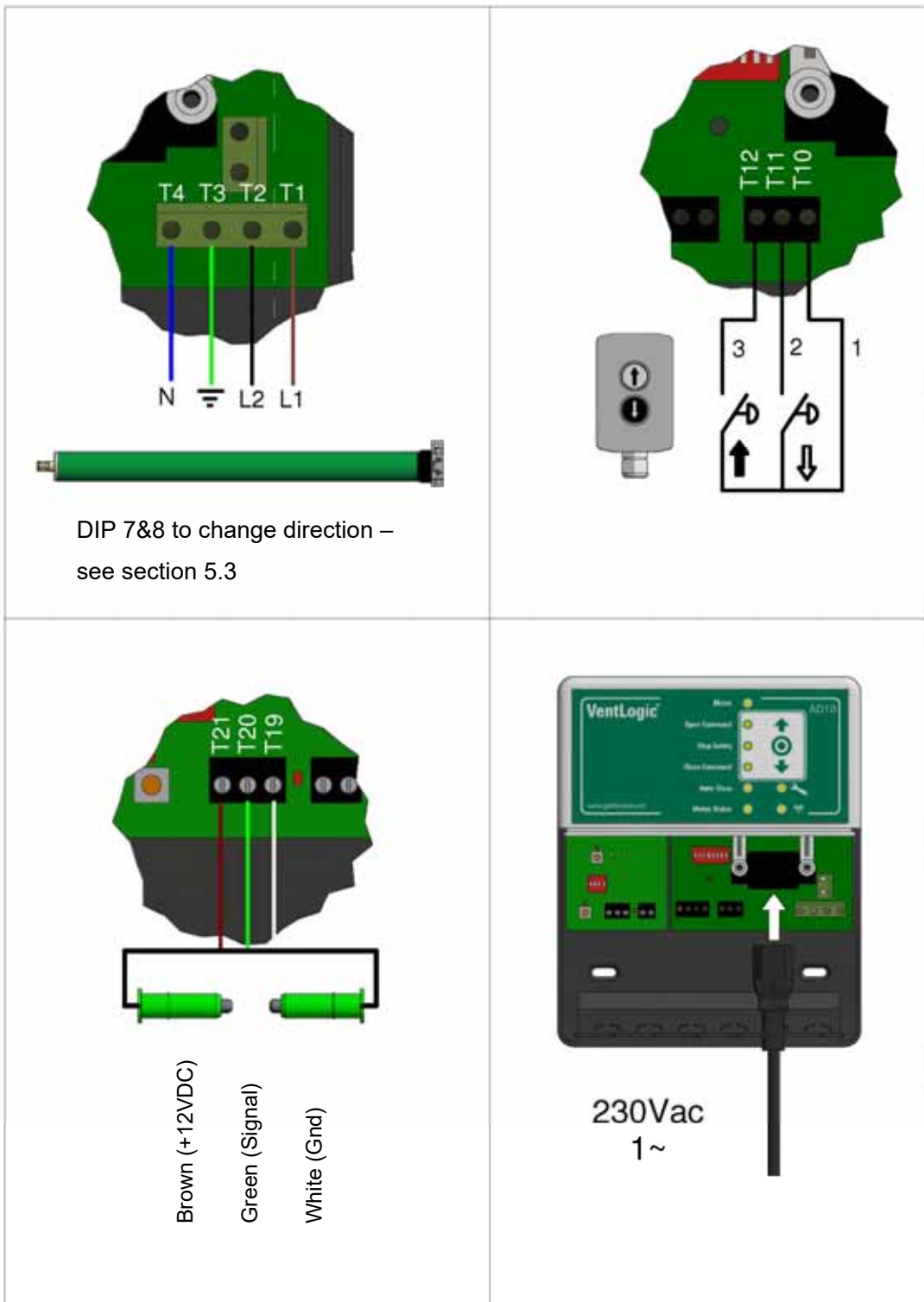

5.3 8 Way DIP Switch



ENG

Number	Function
1	External Switch OFF = Enabled ON = Disabled [Default = OFF]
2	Auto-Close Feature OFF = Disabled ON = Enabled [Default = OFF]
3	AD10 Lid Mounted Buttons OFF = Enabled ON = Disabled [Default = OFF]
4	Not Used
5 & 6	Mode of Operation Normal Operating Mode = 5 - OFF, 6 - ON Commissioning Mode = 5 - ON, 6 - OFF [Default = 5 - OFF, 6 - ON]
7 & 8	Motor Direction Right Hand Drive = 7 - ON, 8 - OFF Left Hand Drive = 7 - OFF, 8 - ON [Default = 7 - ON, 8 - OFF]

5.4 4 Way DIP Switch







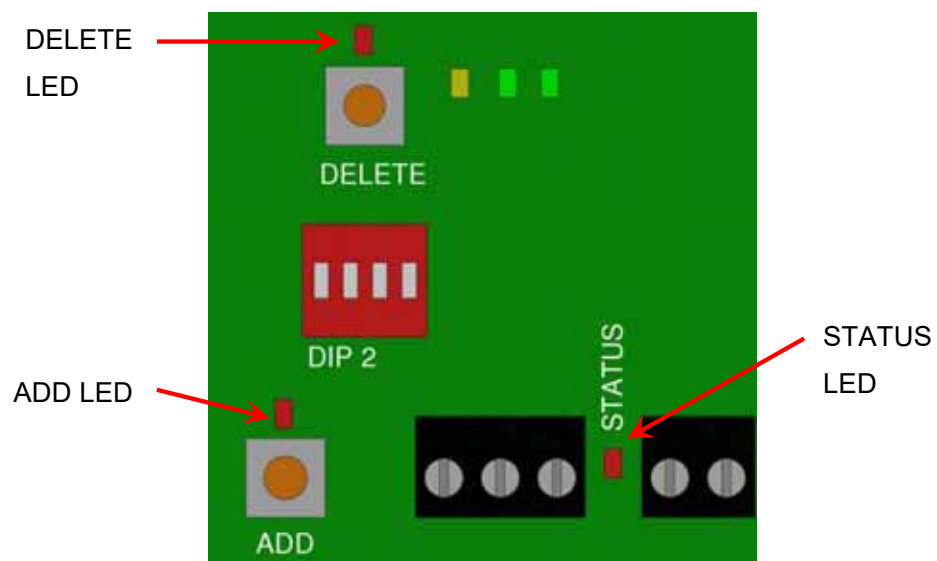

ENG

Number	Function
1	Bottom Tube Transmitter mode ON = Enable Add/Delete OFF = Disable Add/Delete [Default = OFF] Hold-to-Run operation from AD10 buttons only when ON
2	Remote Control Handset mode ON = Enable Add/Delete OFF = Disable Add/Delete [Default = OFF] Motor movement is inhibited when ON
3 & 4	Optical Safety Device Enabled = 3 - OFF , 4 - ON Disabled = 3 - ON , 4 - OFF [Default = 3 - OFF , 4 - ON]

5.5 ADD and DELETE (location)





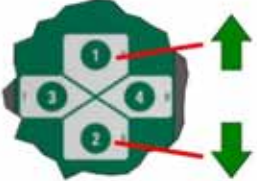
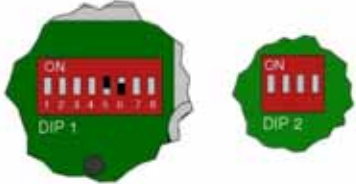

5.6 Commissioning
Commissioning Mode

	<p><u>Enter Commissioning Mode</u> < DIP 5 – ON > < DIP 6 – OFF ></p>
	<p>Commissioning Mode LED ON </p> <p>Operate door using OPEN or CLOSE (in hold to run mode)</p>
	<p><u>Enable Remote Control Handset</u> (only one handset is enabled, all others are disabled)</p> <p>Press  until ALL LED's flash < DIP 1 – ON, DIP 2 - ON></p>
	<p>Press and release ADD button Press channel 3 on Handset</p>
	<p>Use channels 1 or 2 to move door Channel 1 – OPEN (hold-to-run) Channel 2 – CLOSE (hold-to-run)</p>
	<p><u>Exit Commissioning Mode</u> < DIP 5 – OFF, DIP 6 – ON > < DIP 1 – OFF, DIP 2 – OFF > Turn handset OFF to disable it from commissioning mode</p>

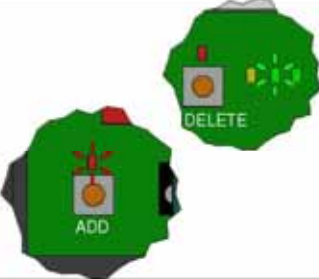
5.7 Adding and deleting Devices

Adding Bottom Tube Transmitter





	<p>< DIP 1 – ON ></p>	<p>ENG</p>
	<p>ADD LED only Solid – no Transmitter added Green LED on solid (x1) (DELETE LED only Solid – Transmitter already added (only one Transmitter allowed))</p>	
	<p>Press and release ADD button ADD LED flashes (After 60 seconds the ADD LED will go Solid. Re-press ADD LED to repeat)</p>	
	<p>Lower door to bottom limit and open again past both magnets using CLOSE and OPEN buttons on AD10</p>	
	<p>ADD LED OFF DELETE LED ON Green LED on solid (x1) < DIP 1 - OFF ></p>	

Adding Remote Control Handset (Premium only- up to 10 handsets per door)

ENG

	<p>< DIP 2 – ON ></p>
	<p>ADD LED only Solid – no handsets added Green LED on solid (x2)</p> <p>ADD and DELETE LED Solid – handset already added, number of flashes on STATUS LED indicates channel number</p>
	<p>Press and release ADD button</p> <p>ADD LED flashes</p> <p>Green LED off (x2)</p>
	<p>Press  (1-4) or (5-8) and channel (1-8)</p> <p>ADD LED flashes rapidly then slowly</p> <p>ADD more handsets on same channel number if required</p>
	<p>STATUS LED flashes to indicate channel number</p> <p>< DIP 2 - OFF ></p>





Deleting ALL Remote Control Handsets

	<p>< DIP 2 – ON ></p>
	<p>DELETE LED on solid Green LED on solid (x2)</p> <p>ADD LED on solid (if less than 10 handsets paired)</p>
	<p>Press and <u>hold</u> DELETE button</p> <p>DELETE LED flashes</p> <p>Green LED off (x2)</p>
	<p>DELETE LED off</p> <p>Green LED on solid (x2)</p> <p>(ADD LED on)</p> <p>< DIP 2 – OFF ></p>







ENG

Deleting Bottom Tube Transmitter

ENG

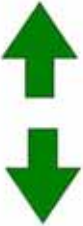
 <p>ON 1 2 3 4 DIP 2</p>	<p>< DIP 1 – ON ></p>
 <p>DELETE</p>	<p>DELETE LED on solid Green LED on solid (x1)</p>
 <p>DELETE</p> <p>< 5S</p>	<p>Press and <u>hold</u> DELETE button</p> <p>DELETE LED flashes</p> <p>Green LED off</p>
 <p>DELETE</p>	<p>DELETE LED off</p> <p>Green LED on solid (x1)</p> <p>< DIP 1 – OFF ></p>

5.8 Auto Close Feature

	<p>< DIP 2 – ON ></p> <p>Auto-Close LED flashes</p> <p>[The previous stored time is restored indicated by number of flashes]</p>
	 <p>OPEN – Increase Seconds (+10secs) 0 > 10 > 20 > 30 > 40 > 50 ...</p> <p>CLOSE – Decrease Seconds (-10secs) ... 50 > 40 > 30 > 20 > 10 > 0</p> <p>0 seconds – immediate close</p>
	<p>OPEN LED flashes to indicate number of minutes</p> <p>CLOSE LED flashes to indicate number of 10 seconds</p>
	 <p>Press STOP to save and exit</p> <p>Auto-Close LED solid</p> <p>To disable Auto-Close <DIP 2 – OFF></p>

ENG

5.9 LED Lights



LED	Solid ON	Solid OFF	Flashing
Mains	Mains present	Mains not present	
Open Command	Open command received and performed	No open command	Open command received but not performed
Stop Safety	Stop command received	No stop command	2-flash: No transmitter added Rapid flash: OSE activated Slow flash: Photocell activated
Close Command	Close command received and performed	No close command	Close command received but not performed
Auto-Close	Auto-close enabled	Auto-close disabled	Rapid flash: Active and auto-close pending Slow flash: Timer adjustment mode
Motor Status	Motor energised	Motor not energised	1-flash: Motor stall detected 2-flash: Relay fault 3-flash: DIP switch error 4-flash: Bottom tube position fault Rapid flash: Motor energised but no motor feedback detected
Commissioning Mode	Controller in motor limit setting mode	Controller in normal operating mode	
Radio	Pairing Mode	No signal received	Signal received

ENG

6 Service and Maintenance

6.1 General Maintenance

The AD10 control unit does not require any general maintenance. A damp cloth (no solvents) can be used to clean the outer surfaces of the control box.



ATTENTION: Under no circumstances should the controller or sensors be cleaned using water under pressure.

ENG

6.2 Battery Replacement

Remote Control Handset

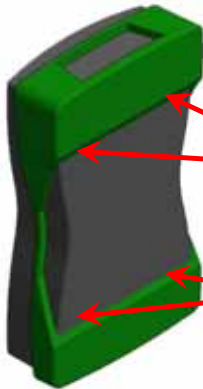

Prise the rubber moulding back and remove the four cross head screws.

Pull the back off and replace the batteries inside

Always replace all batteries

Bottom Tube Transmitter

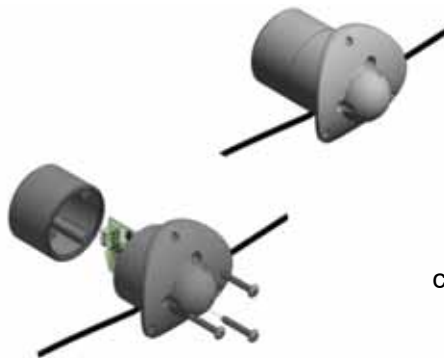

a) Remove the transmitter housing from the bottom tube (3 outer screws)

b) Ensure the unit is dry and clean before opening.

Remove the 3 inner screws and pull the back housing off.

c) Replace the batteries (always replace both batteries together). Ensure unit remains dry and clean and reassemble.

6.3 Fault Diagnostics

Fault	Possible Cause / Solution
Motor Operates in the Wrong Direction	<ul style="list-style-type: none"> • Check motor wiring – see section 5.2 • Swap DIP switches 7 & 8 – see section 5.3
Nothing happens when a button is pressed	<ul style="list-style-type: none"> • Check that the Mains light is illuminated • Check that the door is not on a motor end limit • Motor cut out on thermal trip, allow to cool. • Check motor/switch wiring. • Check that DIP 1 and DIP 3 (8 way) are OFF • Check Internal Fuse (Isolate Power First) • Check for faulty OSE or damaged edge rubber
Nothing happens when remote control handset button is pressed	<ul style="list-style-type: none"> • Check handset is paired to controller • Check correct channel is pressed • Replace batteries in handset (3 x CR2032)
On closing, the bottom tube stops on bottom limit and does not lock	<ul style="list-style-type: none"> • Check all magnets are present • Check Radio LED when bottom tube passes magnets. If LED does not flash then replace batteries in bottom tube transmitter (2 x CR2032).
<p>In the event that the door fails to respond to a command, press and hold the UP or DOWN button for 5 seconds to move the door in hold-to-run mode.</p>	

ENG

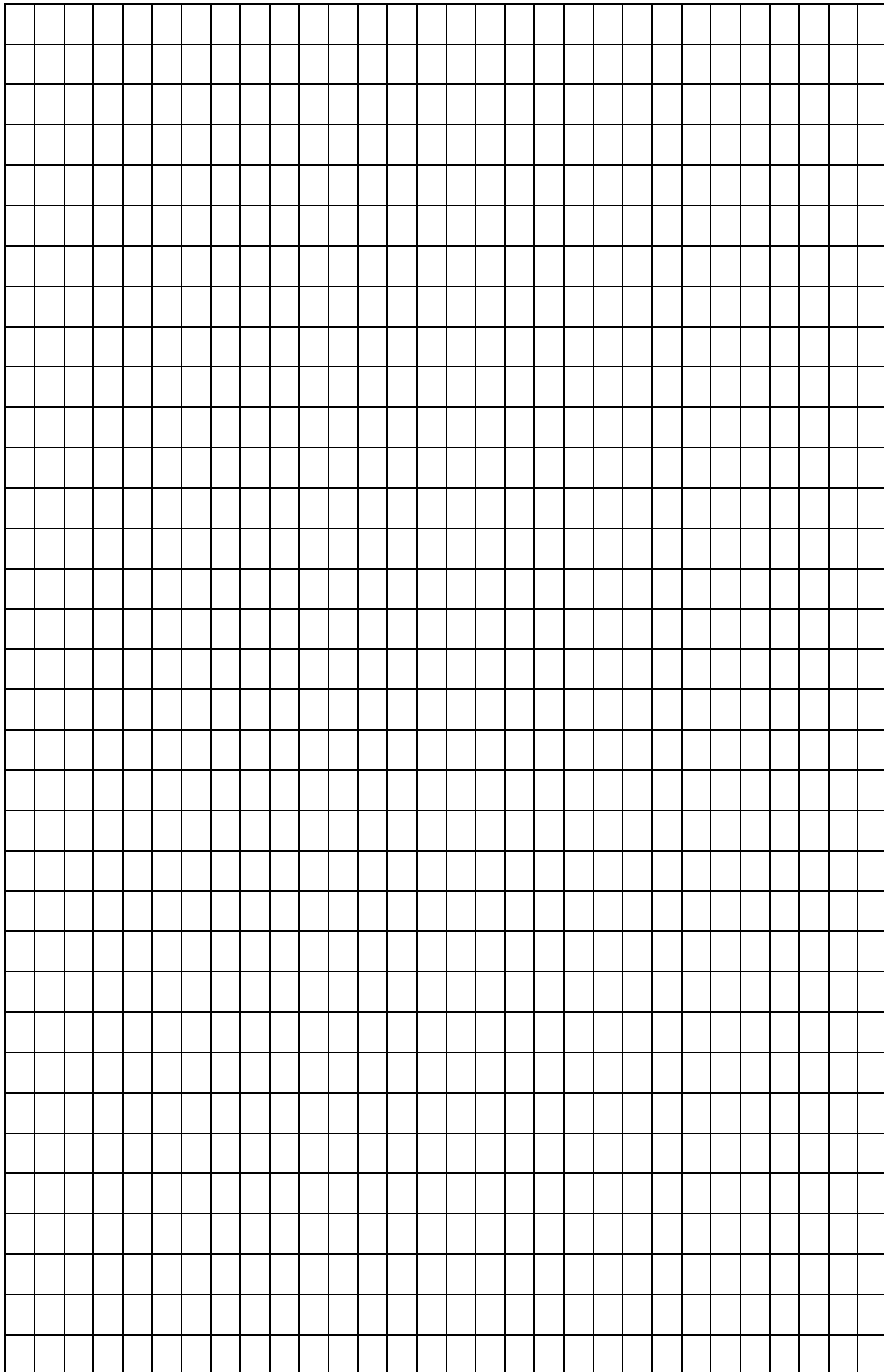

ENG

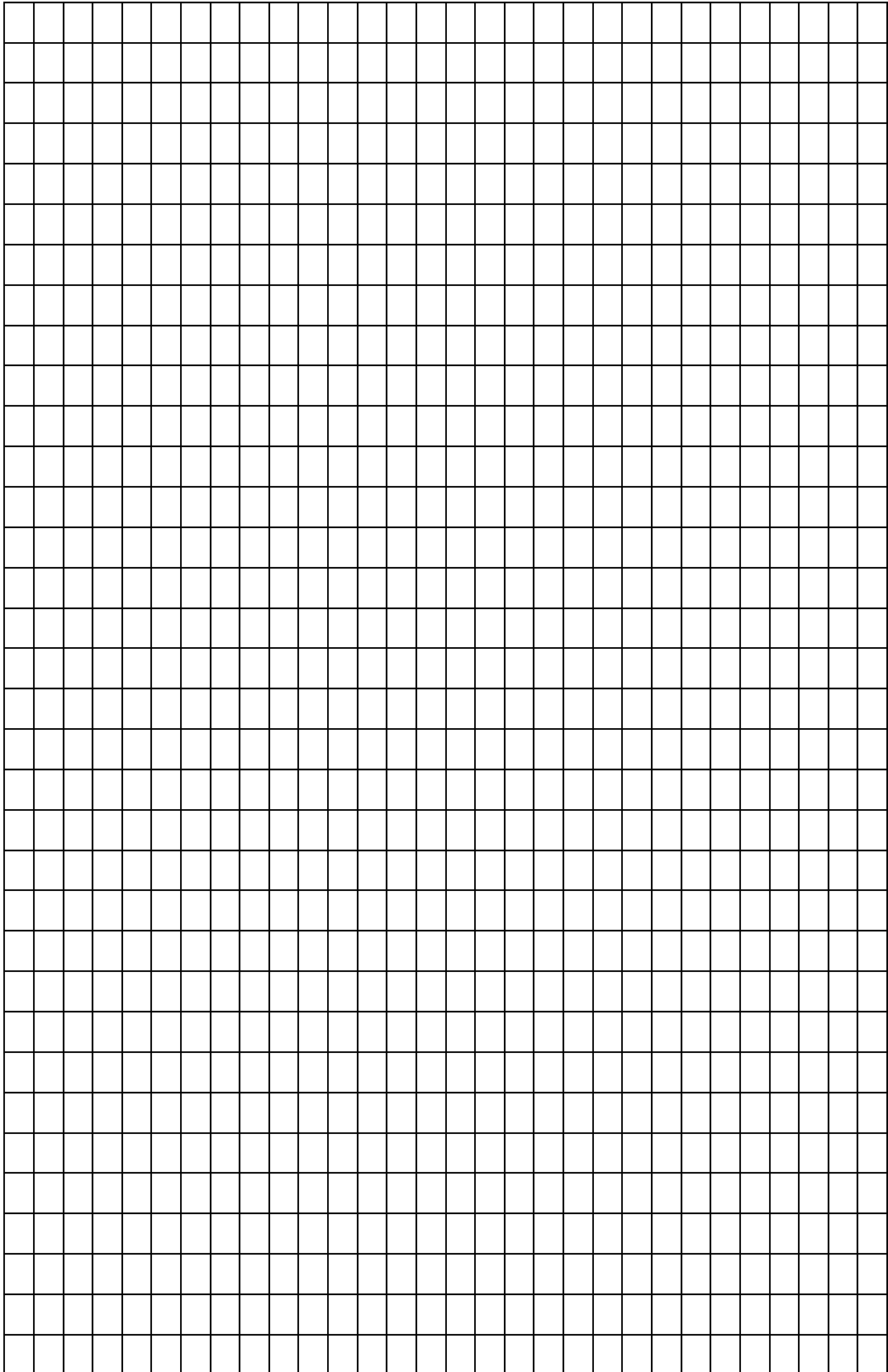

ENG

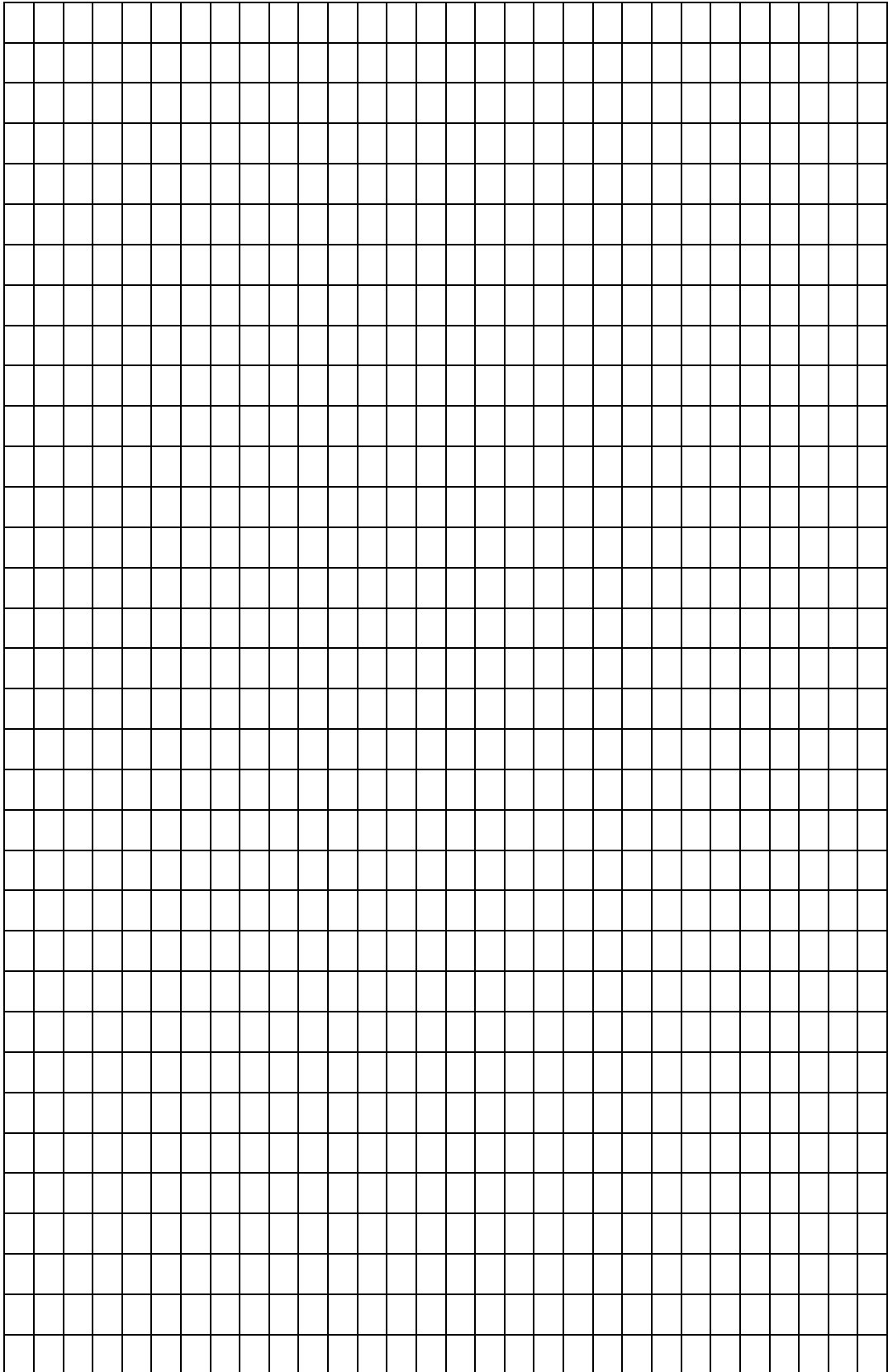

ENG



Manufacturer:

Galebreaker Agri Ltd.
Galebreaker House
New Mills Industrial Estate
Ledbury
Herefordshire, UK
HR8 2SS

Tel: +44 (0) 1531 637 900

Fax: +44 (0) 1531 637 901

www.galebreaker.com

Designed and Manufactured in the UK by Galebreaker Agri Ltd.

Original Instructions

© Copyright Galebreaker Agri Ltd 2017. All Rights reserved.

Model Number MC-AD10/MK1/1709

Instruction Ver: 2018/12/ENG